

LUXMAN

DIGITAL UNIVERSAL PLAYER

DU-80 • DU-7i • DU-50

DU-80

DU-7i

DU-50



Luxman
DIGITAL UNIVERSAL PLAYER DU-80

8
TRU
22
99
77
05

TruSurround
BT

open

stop

LUXMAN CORPORATION

All

For

Music

Universal player under the specifications of audio file.

For providing the moving sound, no efforts are spared to pour in.

The factors that are strongly pursued by the mature universal player is nothing but the "moving sound" which could leave in your memory for a long time and will move your heart at any time. And the factor that could give the highest happiness in the audio file is nothing than the "sound". Of course the image quality is too very important for the universal player. But, no matter how good the image is, if the heard "sound" lack of charm, the interest of the entertainment will reduce haft. The traditional high sound quality technology and the unique high sound technology newly developed by Luxman so far are adequately put into the designs of the totally three types of "NEW" universal players.

DU-80

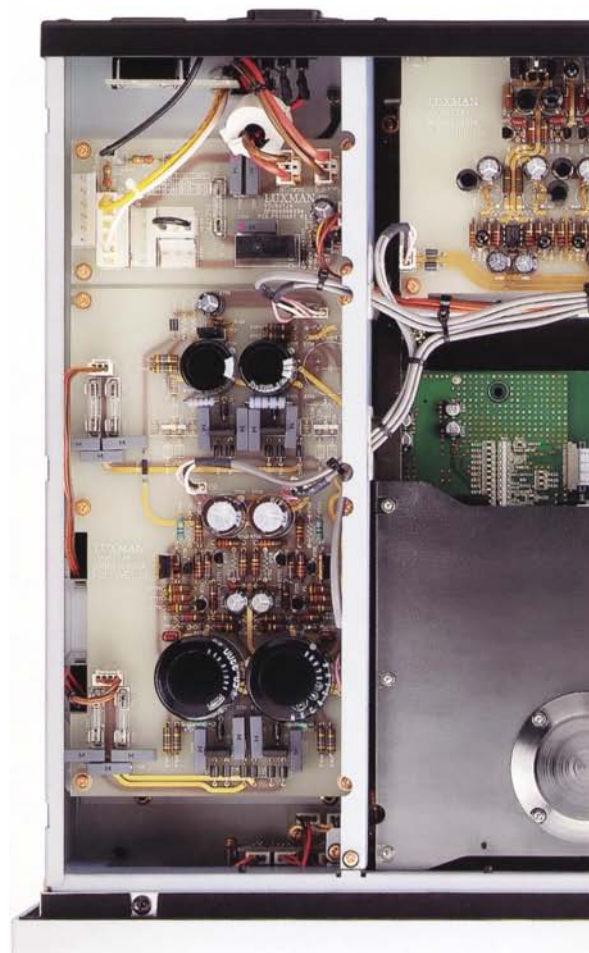

Of course, the highly evaluated "Fluency-DAC" among audio files was built in all types of machines. .

UNIVERSAL AUDIO PLAYER

It is an achievement accomplished by the universal audio player developed by Luxman with its design target aiming at gaining sound quality much better than that of single CD player.

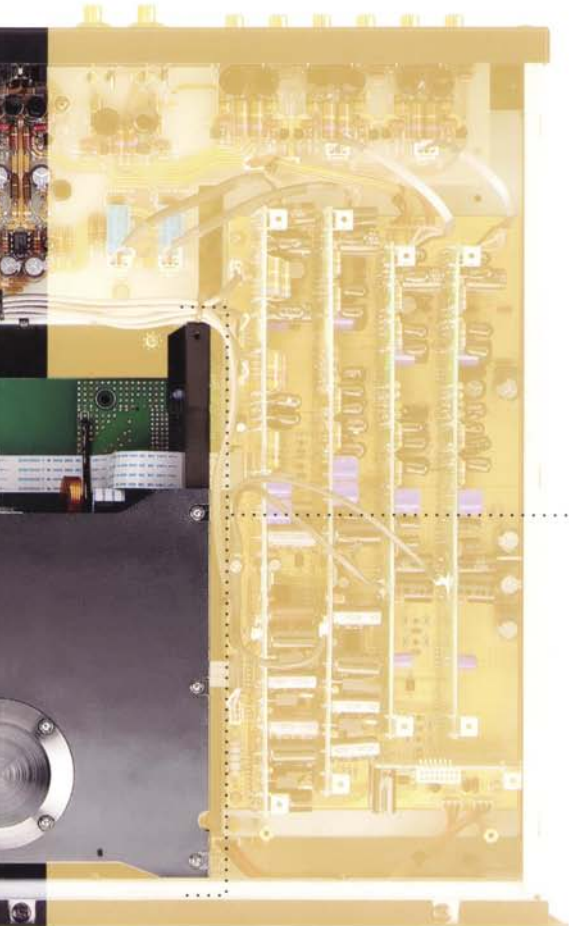

Internal construction of DU-80

High rigidity mechanic support block has realized most correct single trace.

Many efforts are made on drive mechanism which rotates the optical disk in high speed, for completely solving the both vibrations from the mechanism itself caused by the rotation action and the outside vibrations coming from case body. The high rigidity mechanic support block with an excellent shock-proof feature and could even control the air flowing inside the drive mechanism was newly developed by Luxman and was built in DU-80. The total weight of this mechanism block is less than 3.5kg, and the information carved on the disk could be picked up correctly.



DU-80

Peel coat gold plating board instead of Resisto-coating

DU-80 DU-7i DU-50



Lexman has aimed at making the resisto coating on the signal line of the board exert as little impact as possible on the sound. But, the peel coat gold plating board completely replacing the resisto was widely adopted in the audio circuits. And the pattern width of signal line was maintained at a certain scale, and a smooth transferring path which could depict a smooth curve in answering the requirements. Maybe there are some worries, but we all know quite well that we must try our best to obtain the good sound in the transferring of signal with little stress.

The bottom chassis with a complex construction with an excellent anti-vibration feature

DU-80 DU-7i DU-50



In the bottom chassis of DU-80, epoxy resin was filled in the solid iron-made case, and still the complex construction with high rigidity and non-resonance assembled by the thick copper plate was adopted. The overall case body was kept at a balance of lower center of gravity, and the un-wanted resonance which

makes the sound hoarse was exterminated. And in the tray part loading the disk, the rabbi coating with a good damping feature was carried out for blocking the resonance. Through the adoption of countermeasure thoroughly against the vibration, the purity of sound was enhanced and the sound information at the micro level was successfully described.

RCA output terminal used in pure audio

DU-80 DU-7i DU-50

The output terminal plays an important role in finally deciding the sound quality of audio machine. For pursuing the stereo reproduction in the highest grade, the RCA terminal at the 2 channel-unbalance output part was completely newly designed for DU-80. An ideal cable connecting environment was built up with the parts precisely machined from the new material copper alloy which has combined the features of the same electric conductivity as copper and the same hardness as brass.



Newly developed non-magnetic AC inlet

The power source line exerting big impact on the sound quality on the whole. Luxman has adopted the original AC inlet aiming at optimizing the sound quality in its newly developed DU-80. In stainless brass terminal part, the non-magnetic nickel treatment and gold plating are conducted, and as a result we need time to check how that will be reflected in sound quality. And it could get the strength firmly supporting the optional attached power source cord JPP-10000. Of course, the Luxman's self-developed line phase sensor which could simply judge the polarity of the power source was built in too.

DU-80



DU-7i



DU-50



Original high sound quality custom-made parts

DU-80 DU-7i DU-50



Luxman, which pursues the better sound quality with great care by selecting the "material for sound" one by one, has paid its attention to the transferring circuit of audio signal to an extreme extent. 6N quality's copper cable was extensively used as the wiring material of audio signal in DU-80. In addition, the block condenser with low-medium rate was built in audio power part with a discrete construction. In the analog output circuits of all types of machines, the large capacity custom-made refined resistors specially used for audio are used for improving sound quality.

The independent fluency perfection DA converter

DU-80 DU-7i DU-50



This is the sound quality of stereo reproduction considered as the highest frequency in the listening environment of audio file. As for front L/R output, the "FE type DAC" (FN1242A), which could be called the aesthetic consciousness of Luxman is driven with the

abundant monaural structure by the DU-80 and DU-7i. The general "Shannon type DAC" (CS4392) adopted in high grade machine was also equipped with a dual construction. This is the secret for earning the sound full of leaping feeling and for enhancing the separation in hearing sense to a big extent. In DU-50, the two types of DAC are installed with the single construction together with the surrounding circuits stressing sound quality. Like DU-80 and DU-7i, one could enjoy the different tone colors by changing the switches set on the front panel.

High inertia discrete power source circuit

DU-80 DU-7i DU-50

In designing the universal player, the quality of power source parts is an important part which will exert direct impact on sound quality. The special power source with good quality earned form the discrete circuit was prepared for audio circuit with a high inertia construction with an excellent transient current supplying function by DU-80 and DU-7i. The large-scale R core type transistor with high efficiency and little magnetic flux leakage in power source was adopted. Because the large capacity type was adopted, the horse power feeling of sound could be enhanced and the security could be guaranteed. The image circuit and digital circuit have taken the responsibilities for controlling the independent switching power source part.

Champagne gold model was also prepared for DU-50

DU-80 DU-7i DU-50



In the basic model of DU-50, except the processing with plaster white which is the symbol of Luxman's new era, the body processed with champagne gold which gives a unified feeling by integrating with L-500f series of pre-main amplifier was also prepared.

Gradation cast iron-made insulator lug

DU-80 DU-7i DU-50

For realizing firm contact with audio board and bottom floor and for effectively reducing the un-wanted vibration transferred via foot, it has adopted the high-grade insulator lug made of gradation cast iron boasting excellent vibration damping function in all models. By setting the insulator lug on the most proper position on the bottom chassis, the remarkably quiet noise floor could be gained without damaging the energy feeling of sound.

High level 216MHz/14bit video encoder

DU-80 DU-7i DU-50



It is a certain matter to place a higher requirement on the image quality of universal player. Luxman has installed the high function image process DAC of high level 216MHz/14bit and pure cinema progressive circuit. While pursuing the ultimate excellence in sound quality, the offering of high quality image could not be ignored too. In addition, the video OFF function which could completely shut down the power supplied for image circuit when it was used as audio player was built in. By re-quantizing audio signal (PCM) into 24bit data, the high bit function for gaining smooth sound quality was built in.

Multi-functional remote unit with dimmer function

DU-80 DU-7i DU-50

The remote control unit with excellent operative function was equipped as standard. The adjustment on dimmer (brightness) of FL tube display of the universal player body is possible.



The differences between the impulse response characteristic and the frequency characteristic decided by DAC type

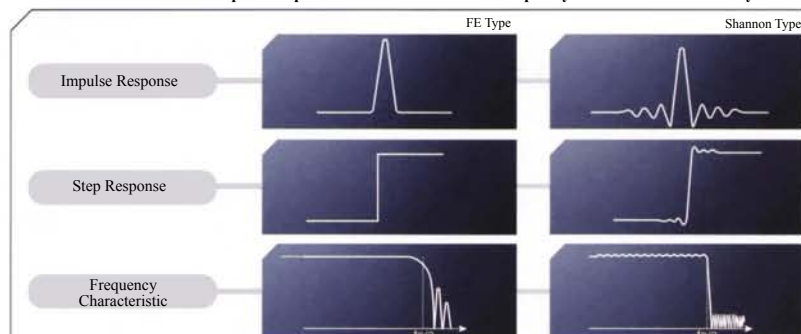

UNIVERSAL AUDIO PLAYER



An optimized music reproduction environment

DU-80 is a thoroughly pursuing highest-level model in the design of high sound quality. The peel coat gold plating board instead of resisto was adopted in audio circuit, the traditional high sound quality elements of Luxman represented by the custom-made resistor specially used in large capacity audio are extensively used. It has taken the ideal construction (SACD has directly treated DSD.) which uses the FE type's high performance DAC in monaural structure in 2 channel output. Featuring a case body design for seeking a countermeasure for control the vibration and earning high rigidity, a tough mechanical support block controlling even the internal air flow was newly developed. It is a design leaving no any gap between the circuit surface and the structure surface.



Internal construction of DU-80







DU-7i The improved model with matured multi-channel functions

DU-7i is the upgraded type of DU-7 winning high opinion. Luxman's high sound quality and image quality are enhanced and the high performances are achieved. The charm in sound quality of "FE-DAC" under the monaural driving should be given full play to the largest extent, and the high sound quality technology earned from the development of upper machine of DU-80 was generously introduced. With the installation of large-scale R core power source transistor, the enforcement of discrete power part and the installation of high function image DAC of 216MHz/14bit are adopted for perfecting the functions.



DU-50 The functions in sound and image of upper machine was inherited

The basic model of DU-50 is a high cost performance machine which purely inherited the quality of DU-7i in sound and image. Not only the real and smooth sound earned from "FE-DAC" symbolizing the universal player of Luxman, but the essence of upper machine such as the built-in of 216MHz/14bit high performance image DAC, the adoption of gradation cast iron-made insulator lug, etc. is full of luxurious atmosphere. The body (DU-50g) manufactured, finished from Champagne Gold was also available.

	DU-80 	DU-7i 	DU-50 
Reproducible disk	DVD audio, DVD video, SACD (Multi-channel, stereo), CD, Video CD, CR-R, MP3 file		
Audio DAC	Shannon: CS4392 dual use (192KHz/24bit) DSD: CS4392 dual use (2.82MHz/1bit) DSD: CS4392 dual use (2.82MHz/1bit)		Shannon: CS4392(192KHz/24bit) FE: FN1242A (192KHz/24bit) DSD: FN1242A (2.82MHz/1bit)
Audio decoder	DVD audio multi-channel, SACD multi-channel, Dolby Digital, DTS		
Frequency characteristic	4Hz—45KHz (DVD audio, SACD), 4Hz—20KHz (CD)		
Overall higher harmonic distortion rate	0.001% (DVD audio, CD), 0.002% (SACD)		
Dynamic range	115dB (DVD audio, SACD), 106dB (CD)		
S/N rate	125dB	123dB	123dB
Video DAC	ADV7314KST (216MHz/14bit)		
Progressive processing	2-3 pull-down type, moving-matching type, perfection mode		
Analog audio output	2channel: L,R (high grade RCA, XLR balance) Multi-channel: FL, FR, C, SW, SL, SR(RCA)	2channel: L,R (RCA, XLR balance) Multi-channel: FL, FR, C, SW, SL, SR	
Digital audio output	Optical output (TOS-Link 1system), coaxial output (RCA 1system)		
Video output	D2(1system), component (RCA1system), S2(2system), composite (RCA 2system)		
Subsidiary equipment	Power switch, video OFF switch/indicator, FE DAC switch/indicator, digital data OFF indicator, FL display OFF indicator, FL display, disk tray, operation key, line phase sensor, AC inlet, remote control, AC cable		
High sound quality circuit, parts	(1) High rigidity mechanical support block, peel coat gold plating board, complex bottom plate, damping coating tray, 6N wiring material, low-medium rate block condenser, original AC inlet, copper alloy output terminal, large-scale R core transistor, discrete power circuit, high quality 4N power cable, large capacity custom-made resistor, gradation cast iron lug, FE perfection DAC, high bit function, video power OFF function, star socket, high inertia power	(2) Large-scale R core transistor, discrete power circuit, high quality power cable, large capacity custom-made resistor, cast iron-embedded wood bottom plate, gradation cast iron lug, FE perfection DAC, high bit function, video power OFF function, star socket, high inertia power	(3) High quality power cable, large capacity custom-made resistor, gradation cast iron lug, FE perfection DAC, high bit function, video power OFF function, star socket,
Supply voltage	AC100V (50/60Hz)		
Power consumption*	21W (standby: 0.3W)	27W (standby: 0.3W)	18W (standby: 0.3W)
Dimension	467(W) X 148(H) X 399(D)mm	467(W) X 148(H) X 394(D)mm	467(W) X 132(H) X 370(D)mm
Weight	21.0Kg	15.0Kg	13.0Kg
	 DU-50g JAN:495813601034-8		

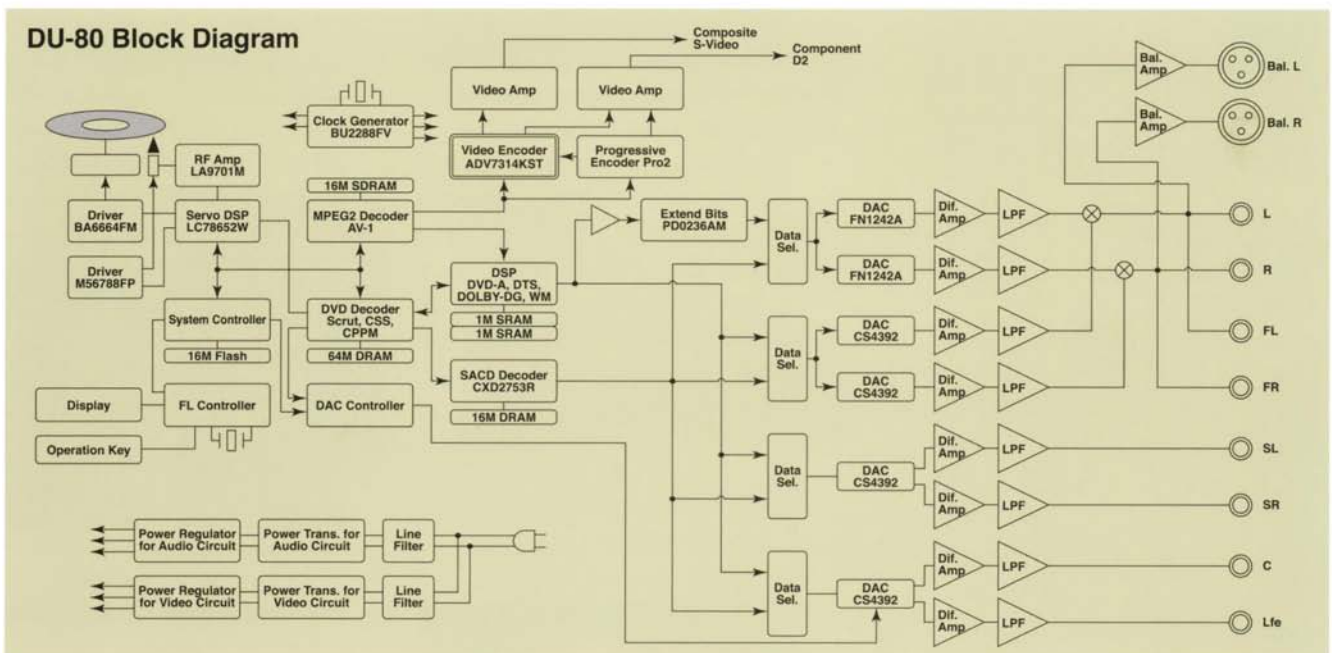

* According to the regulations of Safety Law on Electrical Appliances

* The specifications and appearance are subject to variations without notice beforehand.